

SOYAL[®]

Mini 101 Series

AR-101-H/AR-101-U/AR-101-PBI
Flush-Mount Mini and Compact design for all purposes



Mini Size

As big as a coin, suitable for installation on server rack, meter box, tool cabinet and machine

Bi-Color LED Indicator in Flush Mount Design



Green LED:
Standby Mode / Arming



Red LED:
Swipe Invalid Card / Alarming

Slim Installation

The height of AR101H when attached on the machine panel is 5mm, very sleek and minimalist.

Wiegand Keyboard or Master Card for Keyless Quick Setting

Set up configuration and edit user card setting by entering command with external Wiegand Keyboard or by a tap of a set up Master Card.

Various Panel Selectable



Silver & black plastic panel and stainless steel panel with slim US type, rectangle US type, Rectangle Wide US Type and square EU type

Features



Bi-Color Frame Indicator



Flush Mount Installation



Keyless Editing



Dual-Band Frequency



Watchdog



Anti-Passback



Web



Youtube

- Complete touchless solution with RFID and infrared touchless button
- Built-in hardware watchdog, real time clock, arming, force alarm and door close delay alarm
- Built-in door auto open time zone, holiday edit, door group & time setting. With multi-door control panel, support more time and group sets
- Standalone / Networking / Support Cascade Structure
- Support RS485 communication encryption, SSC (Soyal Security Communication)
- In-field firmware upgrade
- Multi output: door lock output (0.1-600 sec. and toggle mode) & alarm output (1-600 sec.)
- Silent operation mode: push button mute and all mute Auto relock for anti-trailing and sneaking
- Access control, lift control, time attendance, payroll and SCADA: graphic monitoring & remote control function
- Can be an encrypted RS485 reader if utilized with other brand's controller
- Support DESFire tags (Crypto comply with EAL4+)
- Expandable User Capacity to More than 10,000 Users

SPECIFICATION

Model No.		AR-101-H Access Controller	AR-101-U Access Reader	AR-101-PBI Infrared Button
Communication interface	Host	RS485/9600 bps (N, 8, 1) SSC (Soyal Security Communication)	RS485/9600 bps (N, 8, 1) SSC (Soyal Security Communication)	—
	Serial	UART PORT (Output only)/4800 bps (N, 8, 1)	UART PORT (Output only)/4800 bps (N, 8, 1)	—
Frequency		13.56MHz	Dual-Band (125kHz + 13.56MHz)	—
Supported Tags		ISO 14443 Mifare Ultralight, Classic, DESFire EV1, NFC (card simulation)	125kHz: ISO18000-2: EM4001 and EM4095 compatible 13.56MHz : ISO 14443 Mifare Ultralight, Classic, DESFire EV1, NFC (card simulation)	—
Crypto		CC Certification: 3DES Crypto comply with EAL4+	CC Certification: 3DES Crypto comply with EAL4+	—
Reading Range		1-3CM	1-3CM	Active Distance Adjustable AR-101-PBI: 5-20cm AR-101-PBI-S: 0.5-15cm
UID Bits		32	—	—
DI/DO	Digital Input	Egress / Door State	—	COM, NO, NC
	Digital Output*	Door Lock / Alarm (*Required External Relay Output Module)	—	
Doors/Floors Number		1.5 Doors / 32 Floors	—	—
User Capacity		1024	—	—
Event Log		1200	—	—
Indicator	LED	Bi-Color LED Ring Indicator Red= swipe invalid card / alarming status Green= swipe valid card / standby mode	Bi-Color LED Ring Indicator Red= swipe invalid card / alarming status Green= swipe valid card / standby mode	Bi-Color LED Ring Indicator Red= standby mode Green/Blue= release lock
	Buzzer	1	1	—
Extend Port		Wiegand IN	Wiegand OUT	Physical push button
Dimension (mm)		37(H)X 37(W)X31(D)		
Housing Material		ABS		
Color		Black Label Sticker (Customization Label Available by Order)		
Net Weight (g)		approx. 40		
Power Consumption		<3W		
Power Voltage		9-24VDC		
Ingress Protection		NO		
Enviroment		Operating Temperature :-20°C ~ +65°C / Storage Temperature :-25°C ~ +70°C Operating Humidity :20%~90% / Storage Humidity :5%~95%		

INSTALLATION(mm)

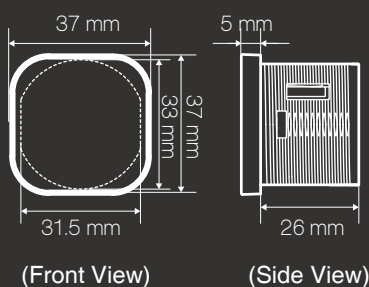

▲ Standard

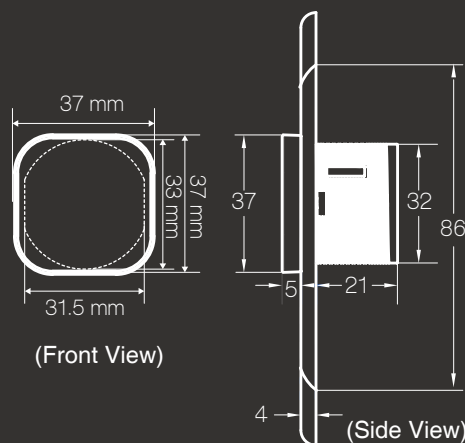

▲ With Panel

HOW TO ORDER

AR-101-XXR1NX1

Product
H= Access Controller
U= Access Reader

Frequency
B=125kHz / D=13.56MHz
S=125kHz+13.56MHz

RTC
R=Built-in RTC / X= None

Communication
1=RS485 / B= Wiegand+RS485

Type
1=Standard
Color
B=Black Panel
Waterproof
N=Non Waterproof

AR-101-PBI-XX-X

Color
GR=Green/Red
BR=Blue/Red

Type
N/A= Standard
S= Short Distance

APPLICATION & STRUCTURE DIAGRAM

● STANDALONE & NETWORKING ACCESS CONTROL

Basic Access: the most basic access, exiting venue is only by pressing a push button

Anti Passback: restrict user to re-enter before exiting venue or increase security level by having access reader at the other side of the door. Both entering and exiting will required swipe card or keyfob for access.

Networking: beside configuration through Wiegand Keyboard and Master Card, you can also link AR-101-H with Soyal converter to PC for configuration via SOYAL Software or for anti-cloning and encryption process.

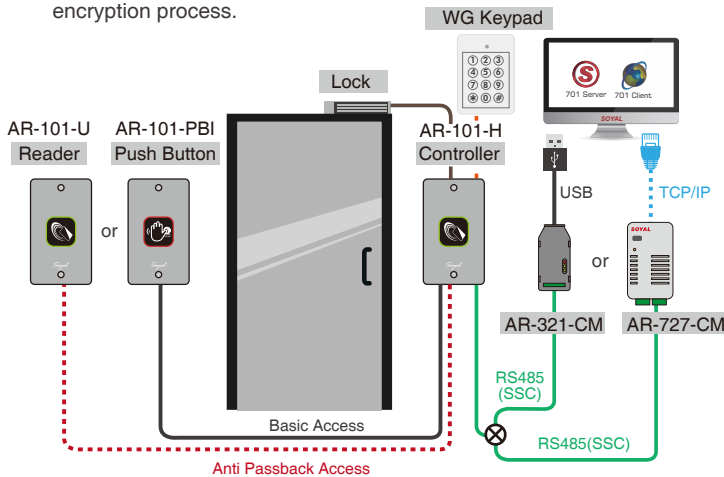

--1024 User, 11 Timezone--

● DUAL FREQUENCY & OUTPUT INTERFACE MINI READER

Not only compatible with both 125kHz and 13.56MHz frequency to read EM, Mifare, and Desfire tags, AR-101-U works with Wiegand and RS485 interface that compatible with SOYAL Access Controller Series and Multi-Door Control Panel for more flexibility and multi functions.

Wiegand Mode

Can be connected to single or dual doors controller

Can be connected to WG port on Multi-door control panel

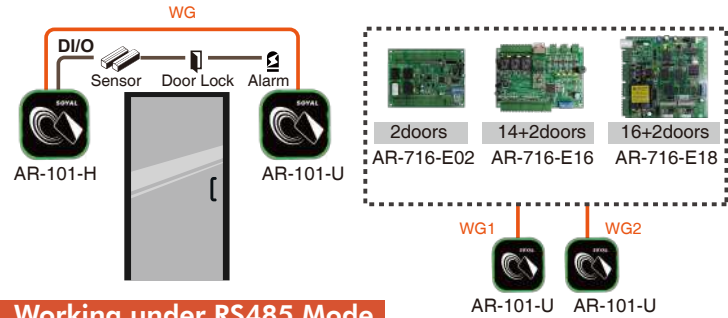

Working under RS485 Mode

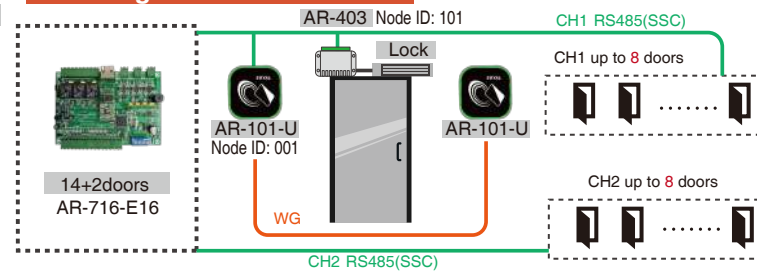

● MAILBOX / STORAGE

access your own mailbox or storage without traditional key, but with card, tags, or even your cellphone supported NFC.

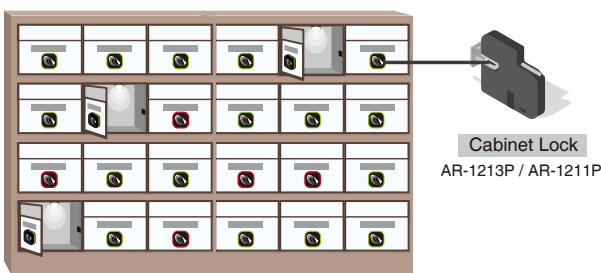

Membership Storage System

Each AR-101-H installed on the storage can only give access to vacant storage.



Suitable for **public space**: Storage rental or membership storage at fitness center and library.

One Person One Storage

Each AR-101-H installed on the mailbox/storage can only read configured valid card for each controller.

Suitable for **private space**: Apartment building, campus locker, and office storage.

● SOFTWARE-FREE PREVENTION LIFT CONTROL

- 1 Swipe card and directly arrived at destination floor
- 2 Touchless Infrared Sensor Lift Call Button
- 3 On-site Software Free Management

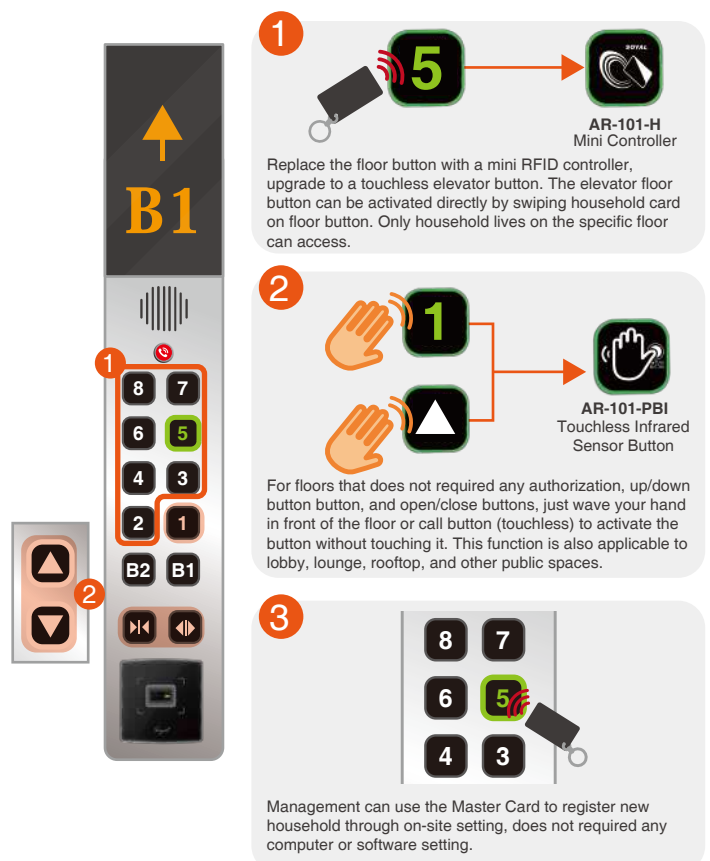

PERIPHERALS / ACCESSORIES

HIGH LEVEL SECURITY

- Anti-Cloning Kits



Mifare Encryption

Encoder: AR-725-P
w/Authorization Tags
Software: Mifare Key



Desfire Encryption

Encoder: AR-837-P
w/Authorization Tags
Software: 323D Master

- Expansion I/O Control



I/O Modules

AR-401 Series:
Multiple Channel I/O Module
AR-403 Series: Tiny Digital I/O Module

NETWORKING

- Software

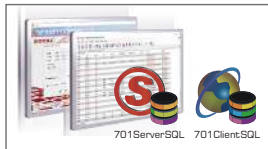

File Based & Data Based Interchangeable Software for Access Control, Time Attendance , Status Monitoring and Configuration

701ServerSQL & 701ClientSQL



Firmware Upgrade

ISP Tools



Parameter Setting

Node 737

- Signal/Interface Converter



Isolated USB to RS-485

AR-321-CM

Isolated RS232 to RS485

AR-321-CM-485232



Ethernet to RS485

AR-727-CM
AR-727-CM-IO-0804M
(with I/O for Fire Alarm to open all doors)



TTL to RS-485

For external module converter

- Large User Capacity & Multi-Door AntiPassback



Multi-Door Control Series

AR-716-E16: 16 Doors IP Control Panel
AR-716-E18: 18 Doors Networking Control Panel

STANDALONE

- Input/Output



Locks

Magnetic Lock
AR-0600M
Electric Bolt Lock
AR-1207 Series
Cabinet Lock
AR-1211-P/AR-1213-P
Electric Strike
AR-YS-130NO/AR-YS-131NO



Door Sensor / Alarm/Siren / Burglary Security System



AR-101-H

- Mini 101 Series

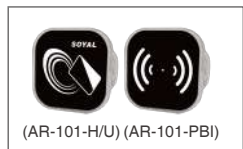

Wiegand Reader

AR-101-U

Touchless Infrared Push Button

AR-101-PBI

- External Relay Output (Door Lock & Alarm)

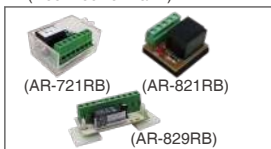

1 Form C relay with time delay
AR-721RB

1 Form C relay
AR-821RB

2 Form C relay
AR-829RB

- Programming



External Wiegand Keyboard

AR-WG-KEYBOARD-V2
(DMOD-WGKBA07)

- Necessary



Keyless Editing

Self programmed master card



Power Supply

BP-W12-1500 (1.5A)
BP-W15-2400 (2.4A)



Proximity Tags

13.56MHz: Mifare Classic, Mifare Desfire, UltraLight
Tags Selection: Thin Card, Round Keyfob, Square Keyfob

FAQ

Q: How to configure and add or delete user on keyless editing?

A:

- Under standalone mode, configuration and add or delete user can be done with Wiegand Keyboard by sending command to controller. Or you can also set up to three master cards for each controller to quickly add and delete users.
- For networking, [Node737](#) Software provide easy setting for keyless controller or you can also choose [701Client](#) for more detailed setting and [Commview](#) by sending protocol command. All Soyal software are available for downloading on Soyal website.

Q: What is the difference between SOYAL Home Series and Enterprise Series Controller?

A: SOYAL access controller classified into two categories in term of specification; Home Series and Enterprise Series. SOYAL Home Series controller has already include all basic standalone and networking access controller that you need. But E series controller provide what Home Series controller has already have, and more advanced features like built in more user capacity, UART Port for extension module, and extension interface like Ethernet and POE.



More FAQ